

PRODUCT #12645-WT

Massachusetts Standard 26" x 4" Watertight Frame & Cover

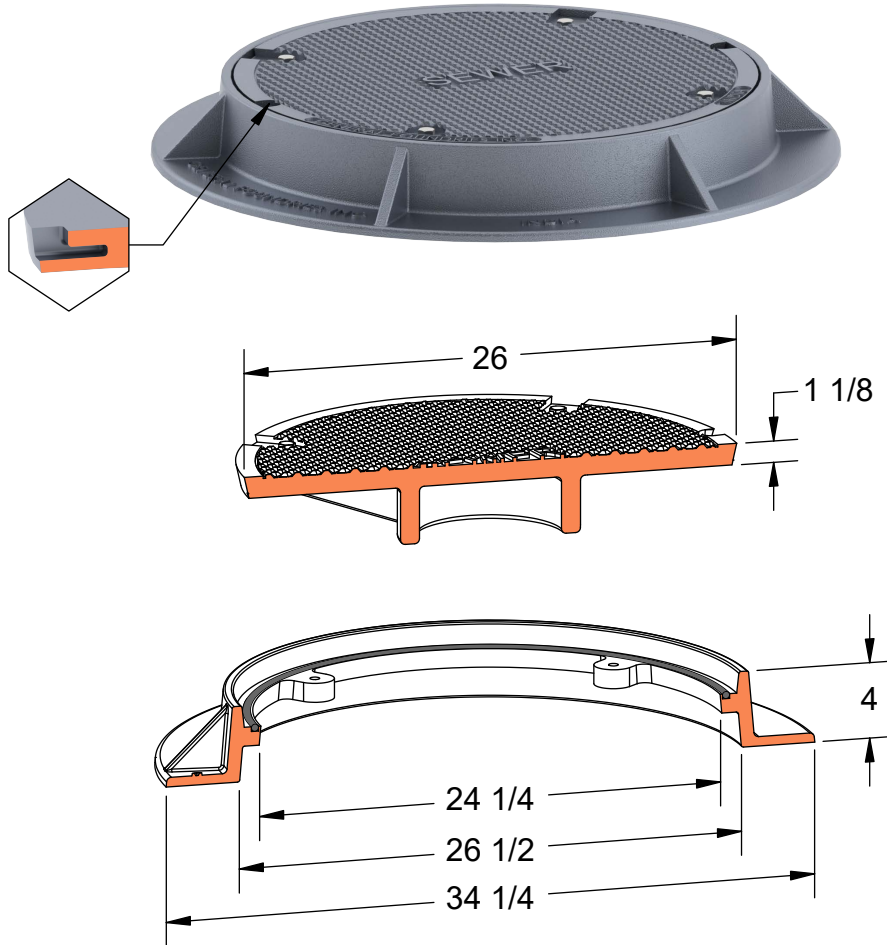

Available Markings

- Drain
- Plain
- Sewer
- Water



Heavy Duty



AASHTO M306



ASTM A48



Gray Iron Class 35B



Bolted



Gasket



Watertight