

PRODUCT #12641-WT
25-3/4" x 4" Watertight Frame & Cover

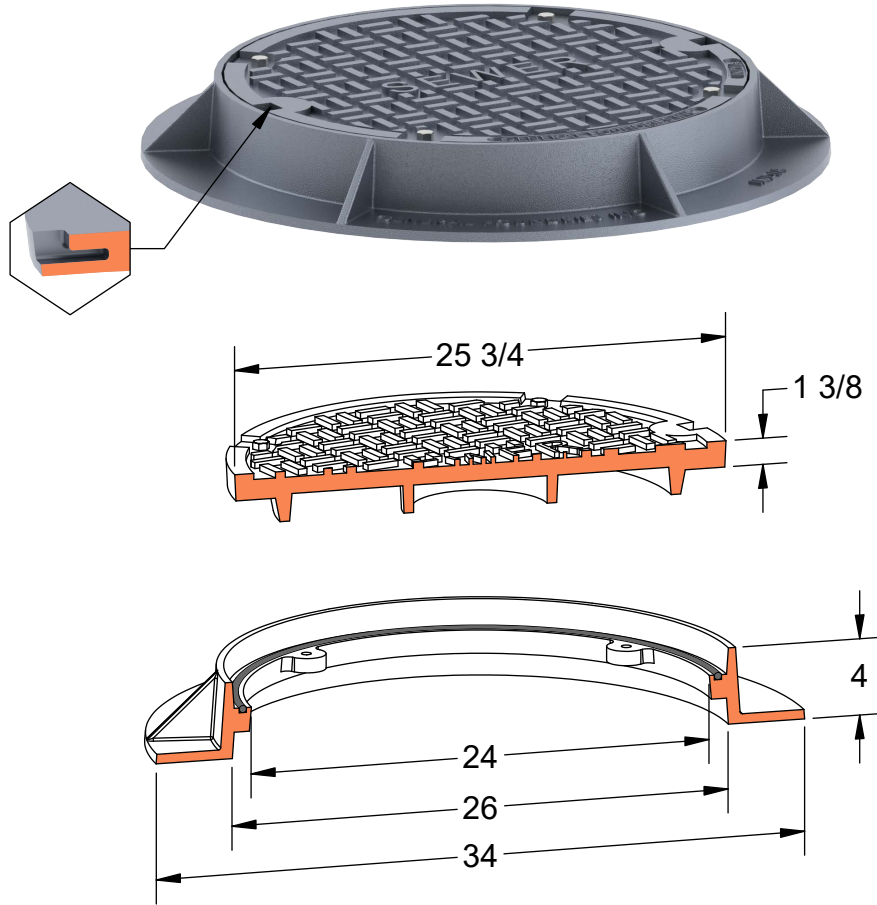

Available Markings
Plain
Sewer



Heavy Duty



AASHTO M306



ASTM A48



Gray Iron Class 35B



Bolted



Gasket



Watertight