

PRODUCT #24884-SQH

New England 8" 4 Flange Frame & Grate

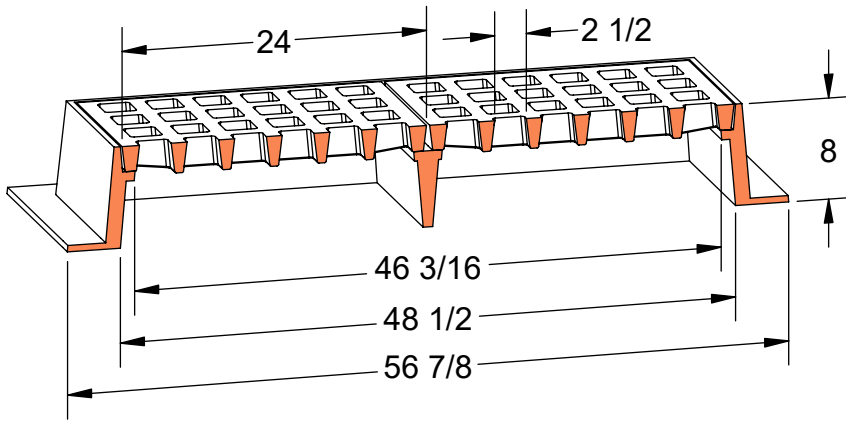
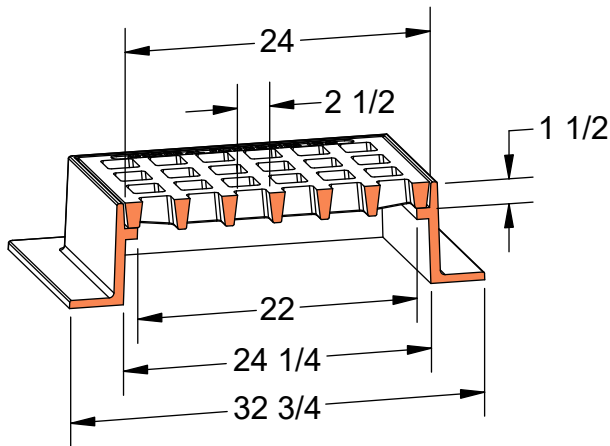

Flow Area
~225 in²

24884-CAS

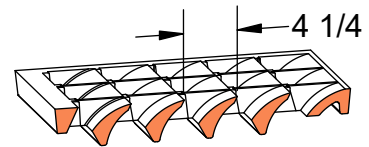
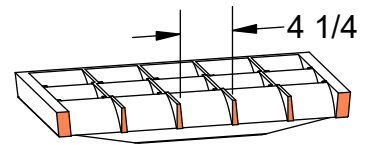

Flow Area
~450 in²

24884-ADA

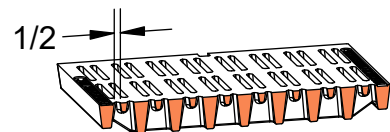
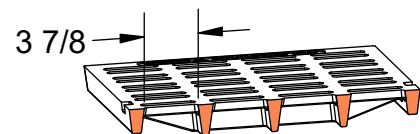
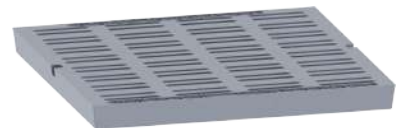

Flow Area
~140 in²



Heavy Duty



AASHTO M306



Gray Iron Class 35B



Solid Cover Available



Risers Available



ADA Compliant