

**PRODUCT #22618-8N**

B-Inlet Frame, Grate, 8" Curb (N-Style), Back Plate

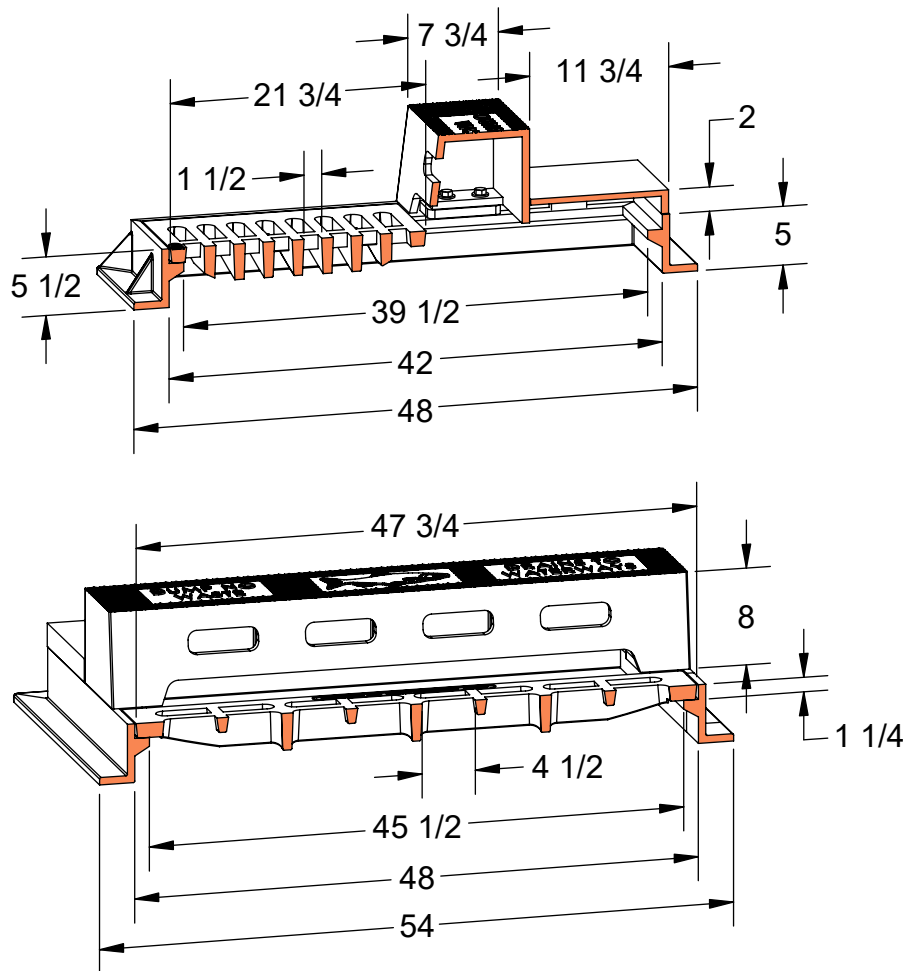

**Flow Area**  
~415 in<sup>2</sup>



Heavy Duty



AASHTO M306



ASTM A48



Gray Iron Class 35B



Bicycle Safe