

PRODUCT #22596-6R

NYC Type 3 Frame, Grate, 6" Curb (R-Style)

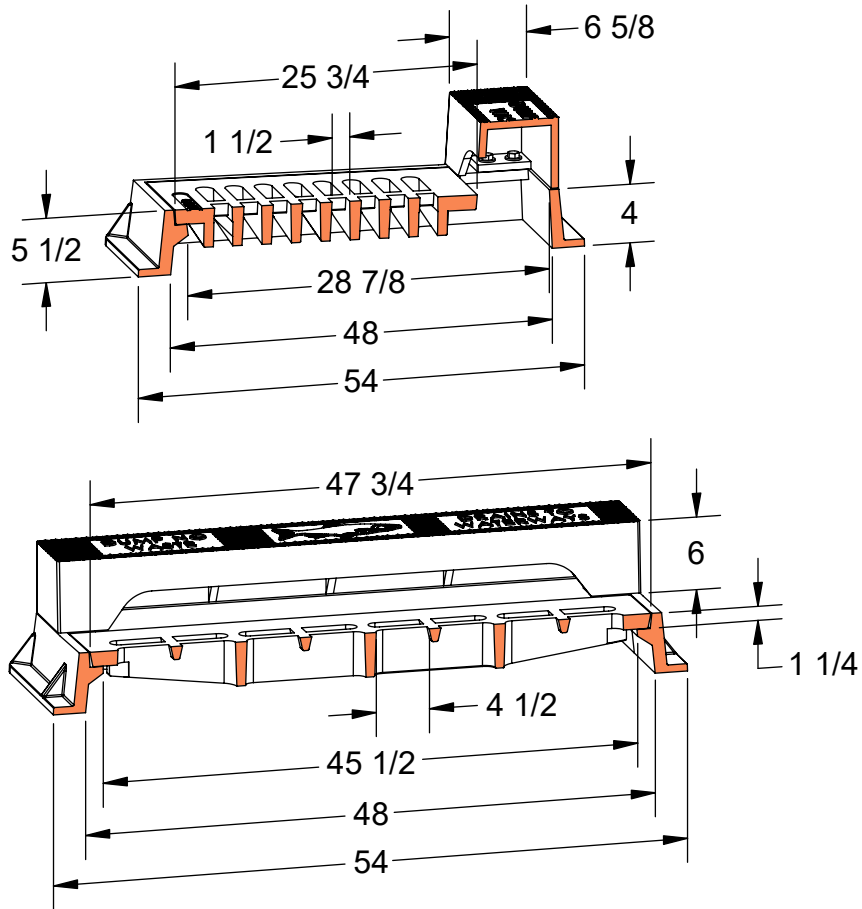

Flow Area
~415 in²

Notes

Frame conforms to NYC DEP STD. DWG. SE58B
Grate & Curb conform to NYC DEP STD. DWG. SE59A & SE59B



Heavy Duty



AASHTO M306



ASTM A48



Gray Iron Class 35B



Bicycle Safe