

PRODUCT #22594-6R

NYC Type 1 Frame, Grate, 6" Curb (R-Style), Back Plate

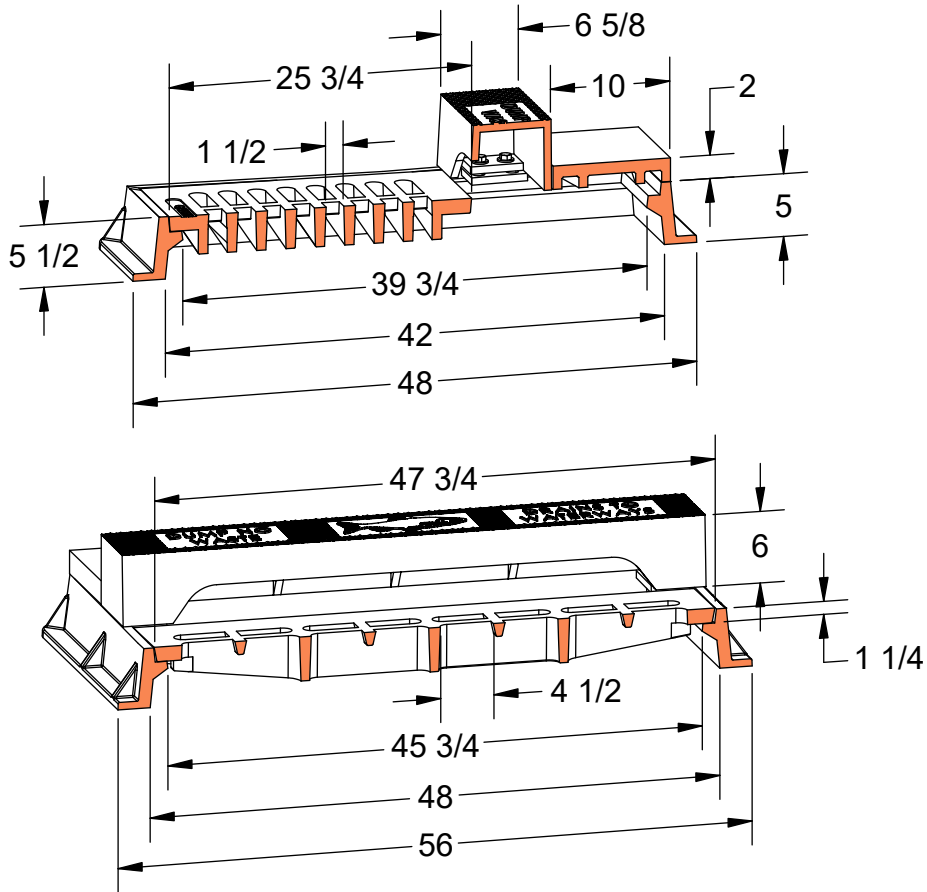

Flow Area
~415 in²

Notes

Frame conforms to NYCDEP STD. DWG. SE57
Grate, Back Plate & Curb conform to NYCDEP STD. DWG. SE59A & SE59B



Heavy Duty



AASHTO M306



ASTM A48



Gray Iron Class 35B



Bicycle Safe