

PRODUCT #22483-SQH

New England 8" 3 Flange Frame & Grate

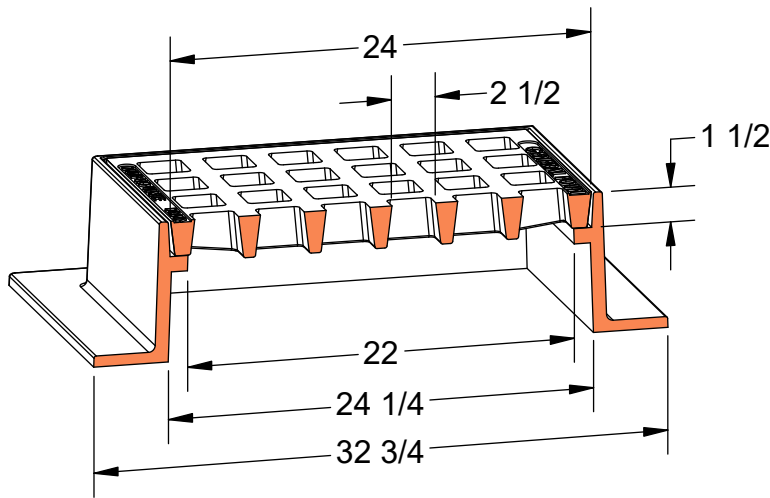

Flow Area
~225 in²

22483-CAS

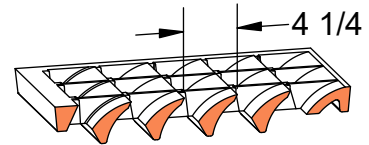
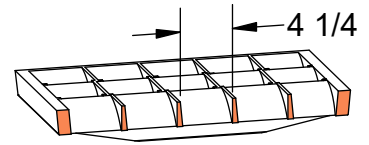

Flow Area
~450 in²

22483-ADA

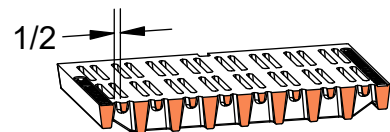
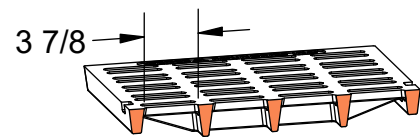
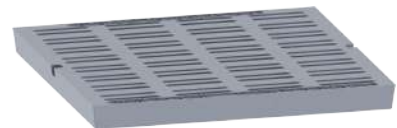

Flow Area
~140 in²



Heavy Duty



AASHTO M306



Gray Iron Class 35B



Solid Cover Available



Risers Available



ADA Compliant