

PRODUCT #22463-SQH

New England 6" 3 Flange Frame & Grate

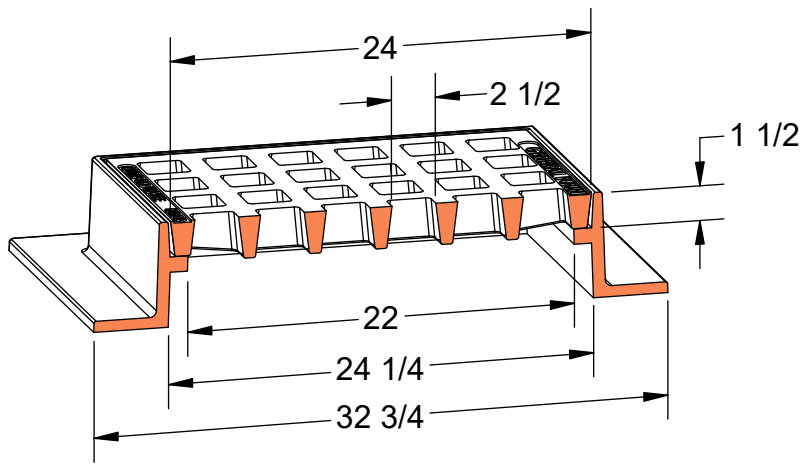

Flow Area
~225 in²

22463-CAS

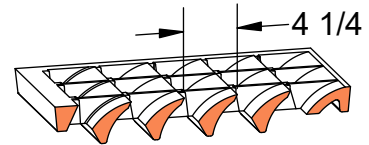
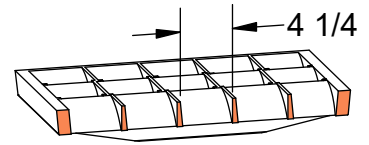
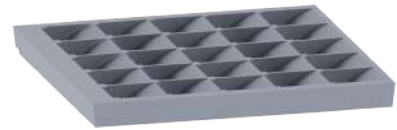

Flow Area
~450 in²

22463-ADA

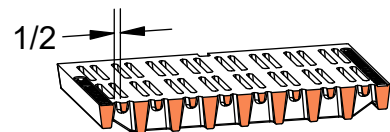
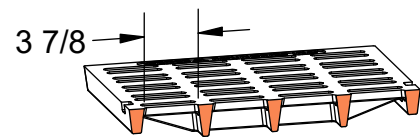

Flow Area
~140 in²



Heavy Duty



AASHTO M306



Gray Iron Class 35B



Solid Cover Available



Risers Available



ADA Compliant