

PRODUCT #22443-SQH

New England 4" 3 Flange Frame & Grate

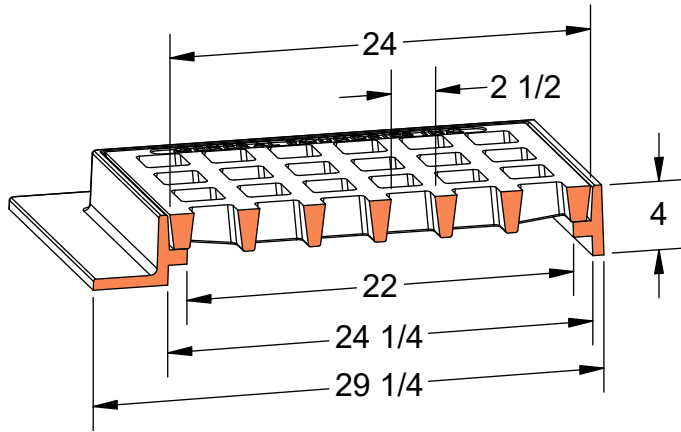
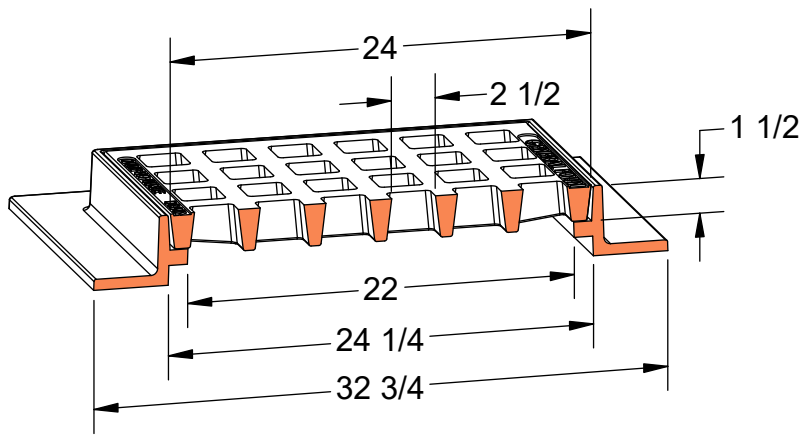

Flow Area
~225 in²

22443-CAS

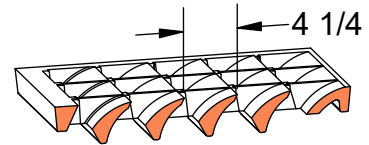
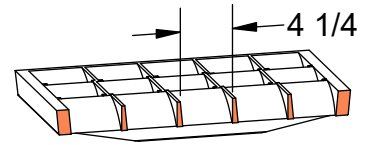
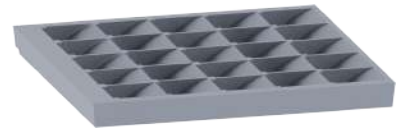

Flow Area
~450 in²

22443-ADA

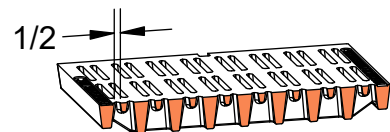
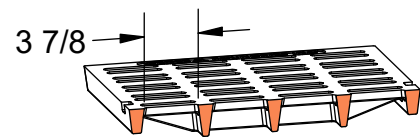

Flow Area
~140 in²



Heavy Duty



AASHTO M306



Gray Iron Class 35B



Solid Cover Available



Risers Available



ADA Compliant