

PRODUCT #17041

Frame & Cover for 4" Cleanout

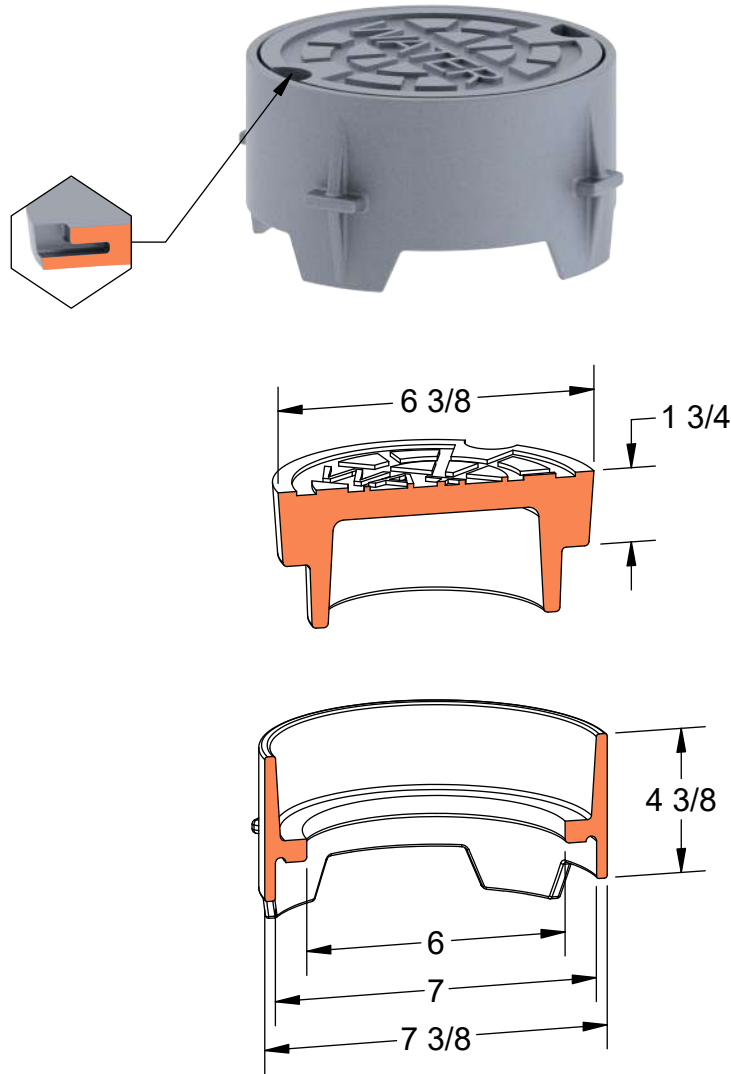

Available Markings

- Fire
- Gas
- Open Left Arrow
- Open Right Arrow
- Plain
- Sewer
- Water



Light
Duty



ASTM
A48



Gray Iron
Class 35B