

PRODUCT #13641-WT

37-3/4" x 4" Watertight Frame & Cover

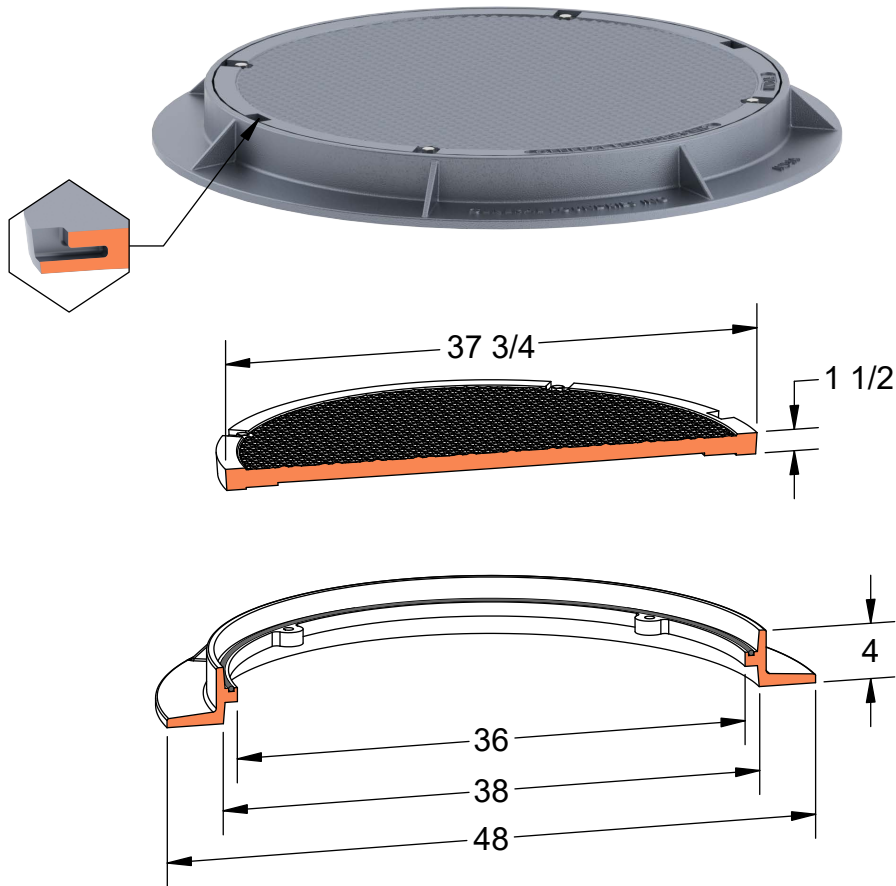

Available Markings

Plain
Sewer



Heavy
Duty



AASHTO
M306



ASTM
A48



Gray Iron
Class 35B



Bolted



Gasket



Watertight